

FITTING INSTRUCTION

Clamp mark in acc. with		Cables joining
ISO	PN	
1	L	Left directional lights
2	+	Rear fog lights
3	31	Ground
4	R	Right directional lights
5	58R	Right side parking lights
6	54	Stoplights
7	58L	Left side parking lights

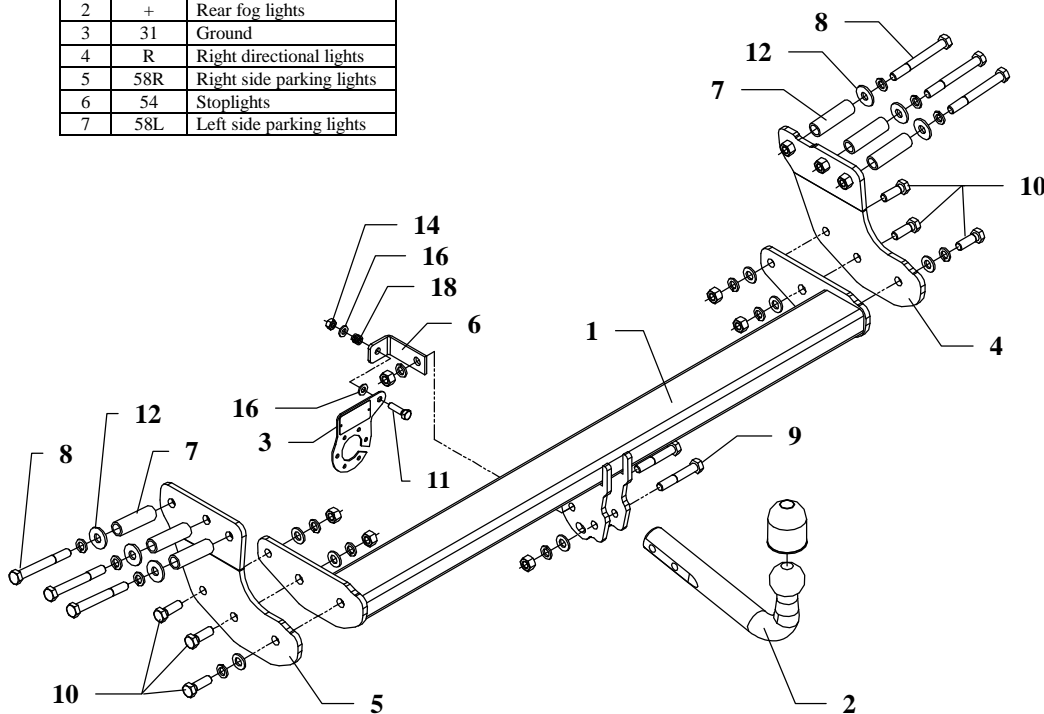

This towbar is designed to assembly in following cars: **VOLVO XC 90**, produced since 2003, catalogue no. **L18** and is prepared to tow trailers max total weight **2250 kg** and max vertical load **90 kg**.

From manufacturer

Thank you for buying our product. Their reliability has been confirmed in many tests. Reliability of towbar depends also on correct assembly and right operation. For this reasons we kindly ask to read carefully this instruction and apply to hints.

The towbar should be install in points described by a car producer.

The instruction of the assembly

1. Disassemble a spare wheel and rear light unit.
2. Get lower the muffler from last handle.
3. Find original holes in chassis members and open it.
4. To opened holes put distance sleeves (pos. 7)
5. To chassis members fix side brackets (pos. 4 and 5) using bolts M12x100mm (pos. 8) and big washers $\varnothing 32 \times 13 \times 3$ mm (pos. 12).
6. Between installed side brackets put main bar of the towbar (pos. 1) and fix using bolts M12x35mm (pos. 10) as shown on the figure.
7. Cut out fragment of the bumper in axis: width 50mm and depth 95mm.
8. Fix tow-ball (pos. 2) with handle of socket plate (pos. 6) using bolts M12x70mm (pos. 9) from accessories.
9. Fix socket plate (pos. 3) according to the figure.
10. Tighten all bolts according to the torque shown in the table.
11. Reassemble elements disassembled in points 1 and 2.
12. Connect electric wires of 7-poles socket according to the instruction of the car. (Recommend to make at authorized service station).
13. Complete paint layer damaged during installation.

Torque settings for nuts and bolts (8,8):	
M 8 - 25 Nm	M 10 - 55 Nm
M 12 - 85 Nm	M 14 - 135 Nm











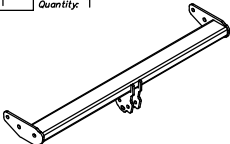



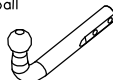
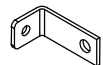

NOTE

After install the towbar you should get adequate note in registration book (at authorised service station).The car should be equipped with:

- Indicators
- Tow mirrors

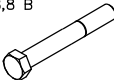
After 1000km check all screws. The ball of towbar must be always kept clear and conserve with a grease.

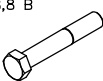
Towbar accessories:

Pos. 1 Name: Main bar Quantity: 1 	Pos. 5 Name: Left bracket Quantity: 1 	Pos. 10 Name: Bolt 8,8 B Quantity: 6 Dim.: M12x35mm 	Pos. 15 Name: Plain washer Quantity: 7 Dim.: Ø 13 mm 
Pos. 2 Name: Tow ball Quantity: 1 	Pos. 6 Name: Handle of socket plate Quantity: 1 	Pos. 11 Name: Bolt 8,8 B Quantity: 1 Dim.: M8x30mm 	Pos. 16 Name: Plain washer Quantity: 2 Dim.: Ø 8,5 mm 
Pos. 3 Name: Socket plate Quantity: 1 	Pos. 7 Name: Distance sleeve Quantity: 6 Dim.: Ø21x2,65mm L=68mm 	Pos. 12 Name: Washer Quantity: 6 Dim.: Ø32xØ13x3mm 	Pos. 17 Name: Spring washer Quantity: 14 Dim.: Ø 12,2 mm 
Pos. 4 Name: Right bracket Quantity: 1 	Pos. 8 Name: Bolt 8,8 B Quantity: 6 Dim.: M12x100mm 	Pos. 13 Name: Nut 8 B Quantity: 6 Dim.: M12 	Pos. 18 Name: Spring Quantity: 1 
	Pos. 9 Name: Bolt 8,8 B Quantity: 2 Dim.: M12x70mm 	Pos. 14 Name: Nut 8 B Quantity: 1 Dim.: M8 	Pos. 19 Name: Ball cover Quantity: 1 



PPUH AUTO-HAK S.J.

Produkcja Haków Holowniczych
Henryk & Zbigniew Nejman
76-200 SŁUPSK ul. Słoneczna 16K
tel/fax (059) 8-414-414; 8-414-413
E-mail: office@autohak.com.pl
www.autohak.com.pl

Towing hitch (without electrical set)

Class: **A50-X** Cat. no. **L18**

Designed for:

Manufacturer: **VOLVO**

Model: **XC 90**

produced since 2003

Technical data:

D-value: 12,2 kN

maximum trailer weight: **2250 kg**

maximum vertical cup load: **90 kg**

Approval number according to Directive 94/20/EC: **e20*94/20*0201*00**

Foreword

This towbar is designed according to rules of safety traffic regulations. The towing hitch is a safety component and can be install only by qualified personnel. Any alteration or conversion of the towing hitch is prohibited and would lead to cancellation of design certification. Remove insulating compound and underseal from vehicle (if present) in the area of the matting surfaces of the towing hitch.

The vehicle manufacturer's specifications regarding trailer load and max. vertical cup load are decisive for driving whereat values for the towing hitch cannot be exceeded.

D-value formula:

$$\frac{\text{Max trailer weight [kg]} \times \text{Max vehicle weight [kg]}}{\text{Max trailer weight [kg]} + \text{Max vehicle weight [kg]}} \times \frac{9,81}{1000} = D \text{ [kN]}$$